

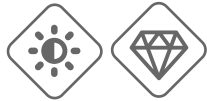

**[promultis]**

# Lightning III Touch Screen

4K Ultra High Definition (UHD) with 32 touch points. The picture quality is excellent and the touch response is superb. The screen is perfect for Business, Education and Commercial use.



Tough Anti Scratch /  
Anti Glare Surface

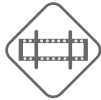

Wall Bracket Included



HDMI, VGA, RS232  
and USB Connectivity



Optional OPS PC



Interactive UBoardMate  
Whiteboard Software



USB slot for Webcam



55" | 65" | 75" | 86" | 100"  
Screen sizes available



32 Touch Points



Anti-bacterial film option  
Currently being tested for COVID-19



Integrated Android  
Use without a connected PC



3 Year Repair or Replace Warranty

**The Promultis Lightning II is a highly versatile, fast and reliable multitouch screen. With a narrow bezel and modern sleek design, this unit is extremely well equipped with the latest in multitouch infra-red technology.**

Available in sizes from 43" up to 86" and available in 1080p HD or 4K UHD variants. The wall or stand mounted Lightning II screen is a very flexible and highly cost-effective solution to a multitude of needs.

Promultis Touch Screens are ideal for:

- Control rooms
- Interactive digital signage
- Education and training rooms
- Presentation environments
- Video conferencing
- Boardrooms
- Reception area



### Integrated Android 5.01

Connect a usb drive to one of the usb ports on the display and upload your media directly into the built-in Android Operating System. View and manage your media assets directly from the usb drive.

In addition, you can open the Play Store and install any app onto the screen.

### Onscreen Menu



Onscreen menu allows you to change volume, change video input, freeze the screen, annotate, and turn off the screen. These options are also accessible from the buttons on the side of the screen.

### Optional PC integration in rear of display

OPS PC with Intel i5 or i7 Processor and built-in A/C and WiFi Router.



### USB port for camera

USB port on the top of the display for usb web camera, allowing you to use the Lightning II as a very powerful video conferencing tool and take advantage of a whole host of photo and video applications.



*In this example Promultis developed interactive software to exploit the screen webcam feature allowing the client's employees to upload their photograph and add a message of support for an on-going product development.*

### Promultis White Board Software



The Lightning II also comes with our industry renowned UboardMate interactive whiteboard software, which allows you to interact with the screen content in a multitude of fun and creative ways, perfect for education and training.

### Optional Collaboration Software

Promultis software solutions help you to make presentations more interactive. Allowing your audience to connect wirelessly and contribute to your presentation and collaborate with each other from their own devices. Participants can contribute, add their own notes, capture content and save that session for review at a later date. Enhance meetings, presentations, training and teaching.

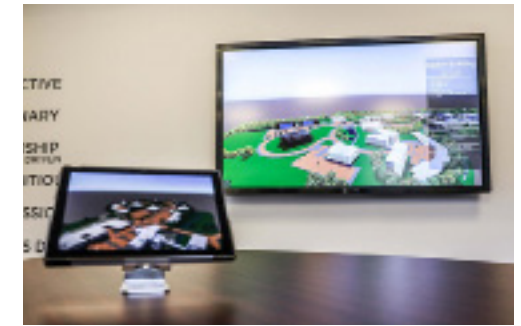

### Optional Bespoke Interactive Software

Engage with customers through a fully branded, interactive application with multi-user, collaborative interface incorporating your corporate identity, images, literature, audio files, videos, web sites and social media.



*Interactive, digital signage solution developed for a city centre transport hub in Scotland featuring wayfinding, local attractions and transport timetables.*

	43" Lightning II Pro	55" Lightning II Pro	65" Lightning II Pro	65" Lightning II Elite	75" Lightning II Elite	86" Lightning II Elite
<b>Dimensions</b>						
Width	1013.5 mm	1311 mm	1527 mm	1527 mm	1749 mm	2007 mm
Height	614 mm	783 mm	903 mm	903 mm	1029 mm	1179 mm
Depth	107.8 mm	112.7 mm	113.7 mm	114 mm	105.3 mm	124.7 mm
Weight	26 kg	40 kg	58 kg	58 kg	82 kg	110 kg
Visible screen	941mm x 529mm	1209.6mm x 680.4mm	1428.4 mm x 803.5mm	1428.4 mm x 803.5mm	1675.8 mm x 928.2mm	1929.2 mm x 1078.6mm
<b>Display</b>						
Touch points	32	32	32	32	32	32
Screen Type	LED Backlit	LED Backlit	LED Backlit	LED Backlit	LED Backlit	LED Backlit
Aspect ratio	16:9	16:9	16:9	16:9	16:9	16:9
Resolution	Full HD	Full HD	Full HD	UHD 4K	UHD 4K	UHD 4K
Pixels	1920 x 1080	1920 x 1080	1920 x 1080	3,840 x 2,160	3,840 x 2,160	3,840 x 2,160
Android OS	✓	✓	✓	✓	✓	✓
Brightness	300 cd/m <sup>2</sup>	350 cd/m <sup>2</sup>	350 cd/m <sup>2</sup>	350 cd/m <sup>2</sup>	450 cd/m <sup>2</sup>	350 cd/m <sup>2</sup>
Contrast	1200	1400	4000	4000	4000	1200
Response Time	12ms	8ms	8ms	10ms	8ms	8ms
Number of Colours	16.7M (8-bit)	16.7M (8-bit)	1.07B (10-bit)	16.7B (10-bit)	10-bit (8bit + FRC)	1.07B (10-bit)
Refreshing Frequency	60Hz	60Hz	60Hz	120Hz	120Hz	60Hz
View Angle	178/178	178/178	178/178	176/176	178/178	178/178
Service Life (Minimum)	> 30,000 hrs	> 30,000 hrs	> 30,000 hrs	> 30,000 hrs	> 30,000 hrs	> 30,000 hrs

<b>Touch System</b>	
Sensing Type	Infrared System (32 point operation : 65 FHD mode 10 point)
Response Time	<10ms(typ)
Response Area	>=Ø3ms
Reported Touch Resolution	32768x32768 (with driver) : 7680x4320 (without driver)
Communication Mode	USB
<b>Ambient Conditions</b>	
Operation Temperature	0°C-40°C
Operation Humidity	10% - 90% RH
Storage Temperature	-20°C-60°C
Storage Humidity	10% - 90% RH
<b>Main Board Module</b>	
Main Chipset Manufacture	MSTAR
<b>Audio</b>	
Max Audio Output (THD=7%)	15Wx2+20Wx1
<b>Connectivity</b>	
Composite Video Input (Mini Jack)	1
Composite Audio Input (Mini Jack)	3
Component Video input(Mini Jack)	0
Component Audio Input (Mini Jack)	0
S-video Input	0
VGA Input:(D-sub)	3

VGA Output:(D-sub)	1
VGA Audio Input	3
VGA Audio Output (Mini Jack)	0
HDMI Input	2 (Support 4K Input)
DP Input	1
A/V Output (Mini Jack)	0
Earphone Jack	1
RS-232C(Type)	1
SPDIF Output(Optical/ Coaxial)	1 (Optical)
USB 2.0	1 (Side) +2 (Front)
USB 3.0	2
USB2.0 for camera For Android & Windows	1
LAN(RJ45)	1
Updating interface	USB
WAN(RJ45)In	1
WIFI router	1 (A/B/G/N)

#### **Supplied Accessories**

AC Power Cable / Operating Instructions / Quick Start Guide / Writing Pen / Remote Control / VGA Cable / USB Cable / HDMI Cable / Guarantee Card

Andriod OS	
System Version	Android 5.01
CPU	ARM Cortex A53 1.5G
GPU	Mali450x4
RAM	2GB

Optional USFF PC integration in rear		
Processor	Intel i5	Intel i7
Graphics	Integrated	2GB Dedicated
Sound Card	Integrated High Definition Audio Stereo	Integrated High Definition Audio Stereo
Networking	Integrated 10/100/1000M Adaption	Integrated 10/100/1000M Adaption
Memory	4G DDR3	8GB DDR3
Hard Drive	500G SATA (SSD option)	M.2 128GB SSD
WIFI	802.11b/g/n /802.11a/b/g/n (optional)	802.11b/g/n /802.11a/b/g/n (optional)
USB(A)	6(4 for USB2.0 2 for USB3.0)	6(4 for USB2.0 2 for USB3.0)
Microphone In	1	1
Earphone Out	1	1
HDMI	1	1
Mini DP	1	1
Lan Port(RJ45)	1	1

Supplied Mounting Bracket			
Width	Height	Depth	Weight
960 mm	240 mm	29.4 mm	8kg

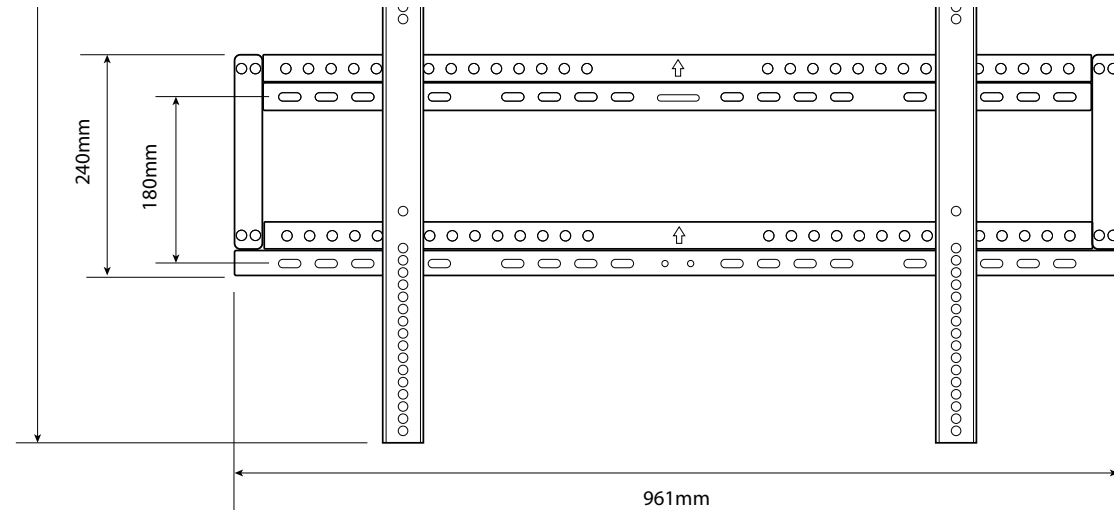



**[promultis]**

# Anti-bacterial Film for Touch Screens

High Performance Touch Screen Protection Film

Surface protection tape  
(PET 38 µm)

Hard coat layer  
(5 ± µm)

PET film  
(100 µm)

Silicon PSA  
Adhesive  
(15 µm)

Release film  
(PET 50 µm)

Currently being rolled  
out to all Mcdonalds  
Restaurant touchscreens



Silicone adhesive  
for clean removal

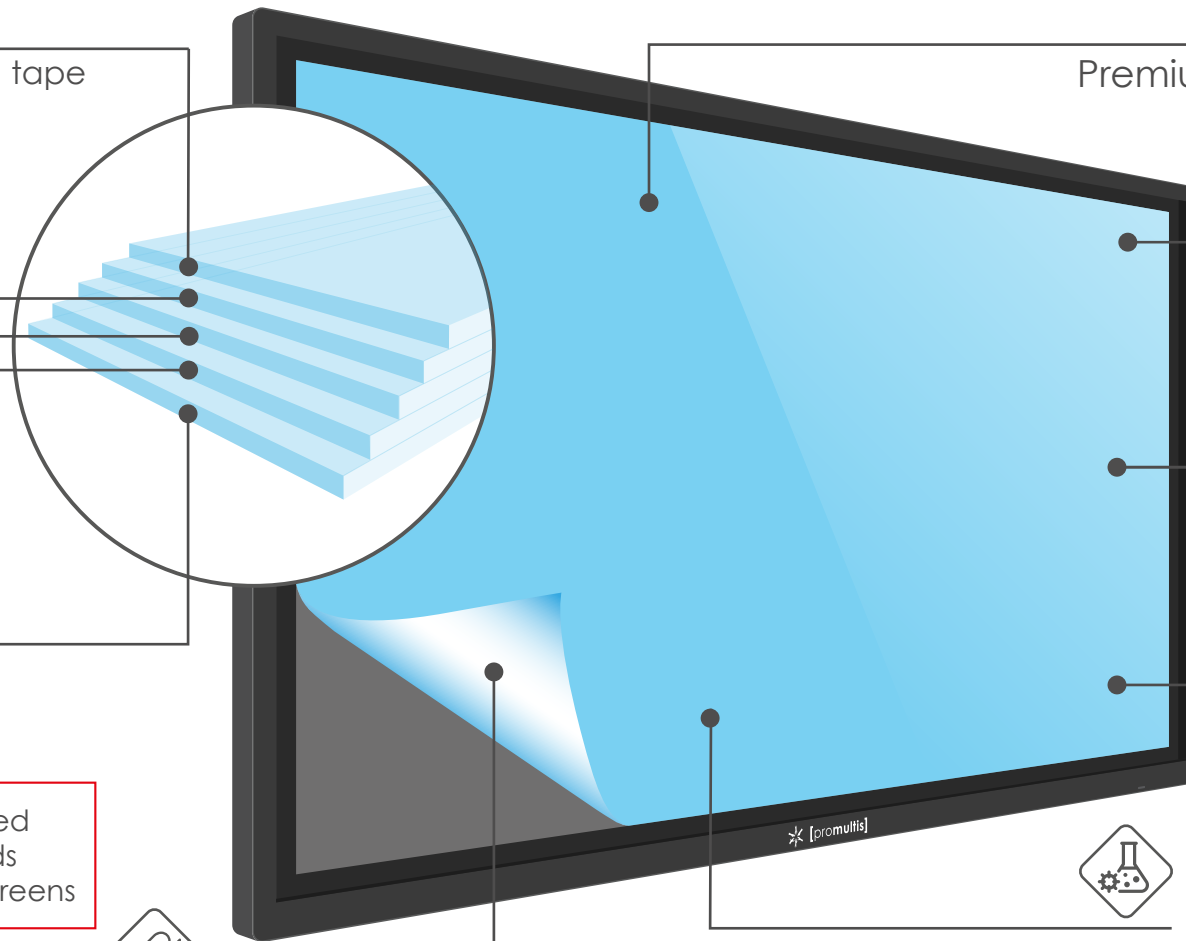

Premium quality transparent  
protection film



32" | 43" | 55" | 65"\*

\*Maximum film size -  
multiple sheets for larger screens



Anti-bacterial, Anti-scratch  
Currently being tested for COVID-19



High grade polyester

Available for all Promultis  
Screens, Totems, Tables & Kiosks



BS EN ISO 22196 tested



# 86" Lightning II Screen

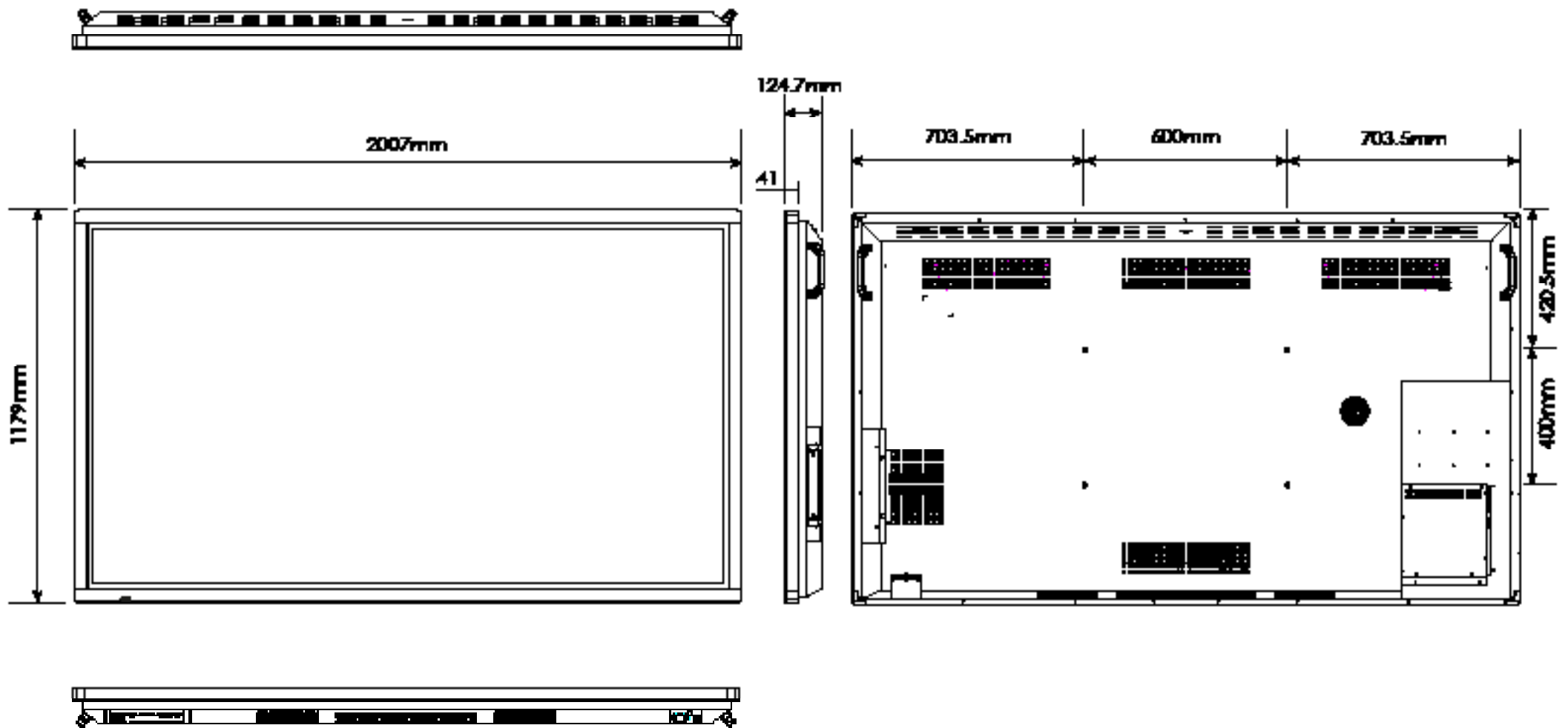

# 75" Lightning II Screen

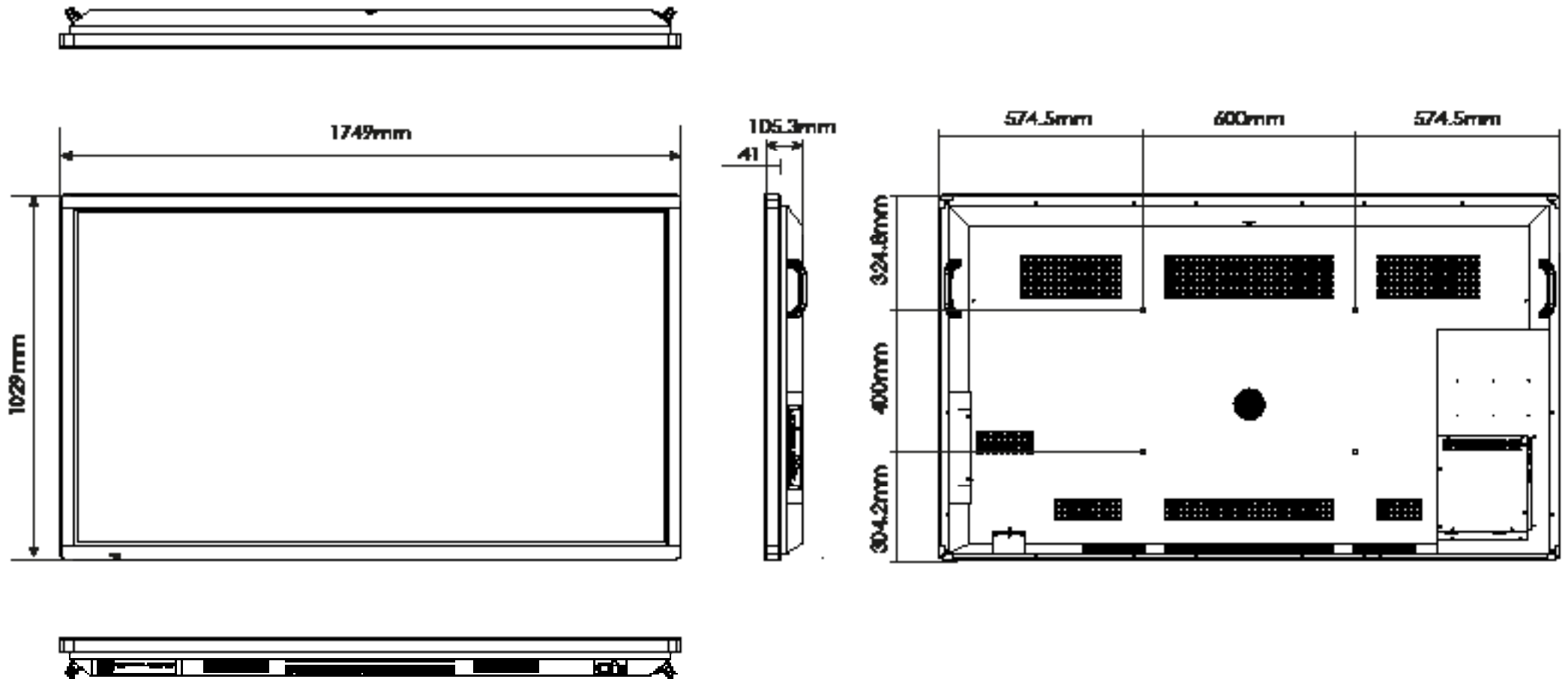



# 65" Lightning II Screen

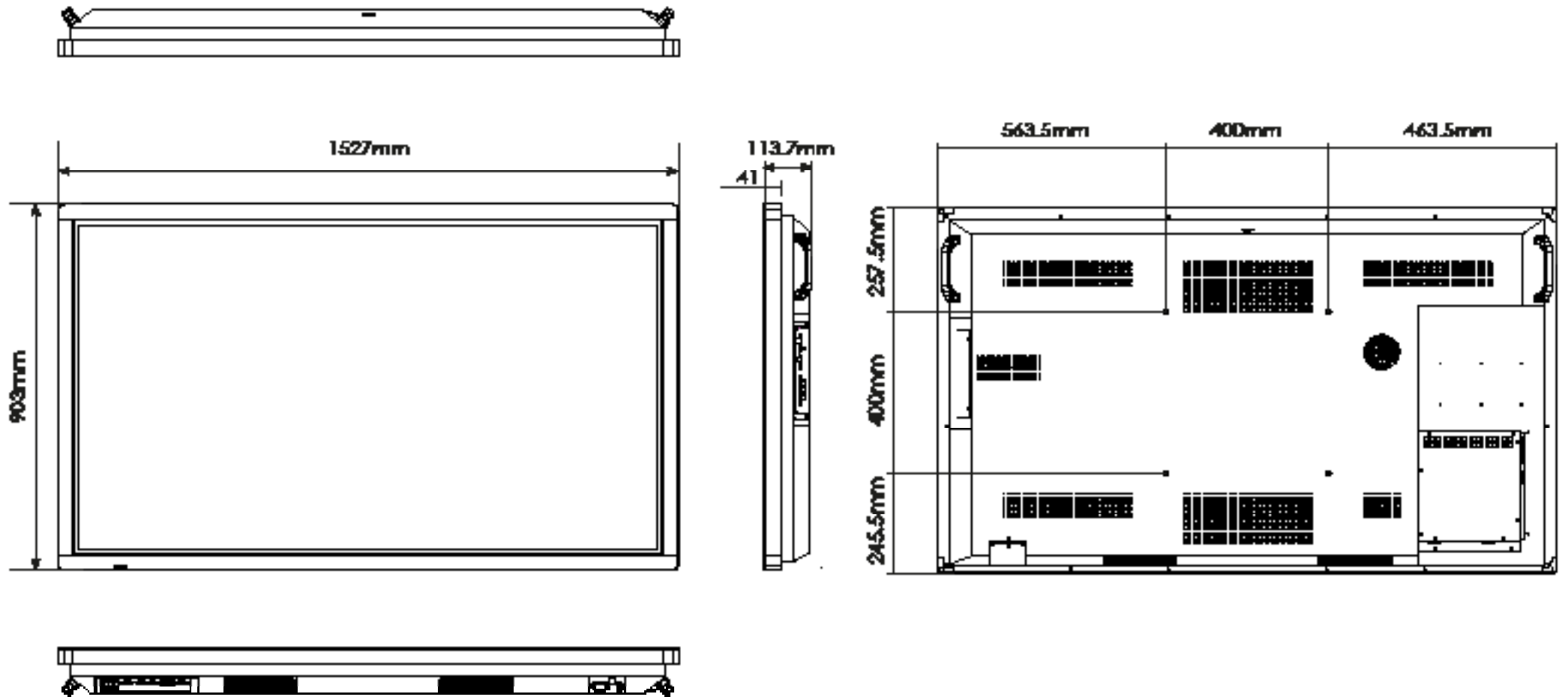

# 55" Lightning II Screen

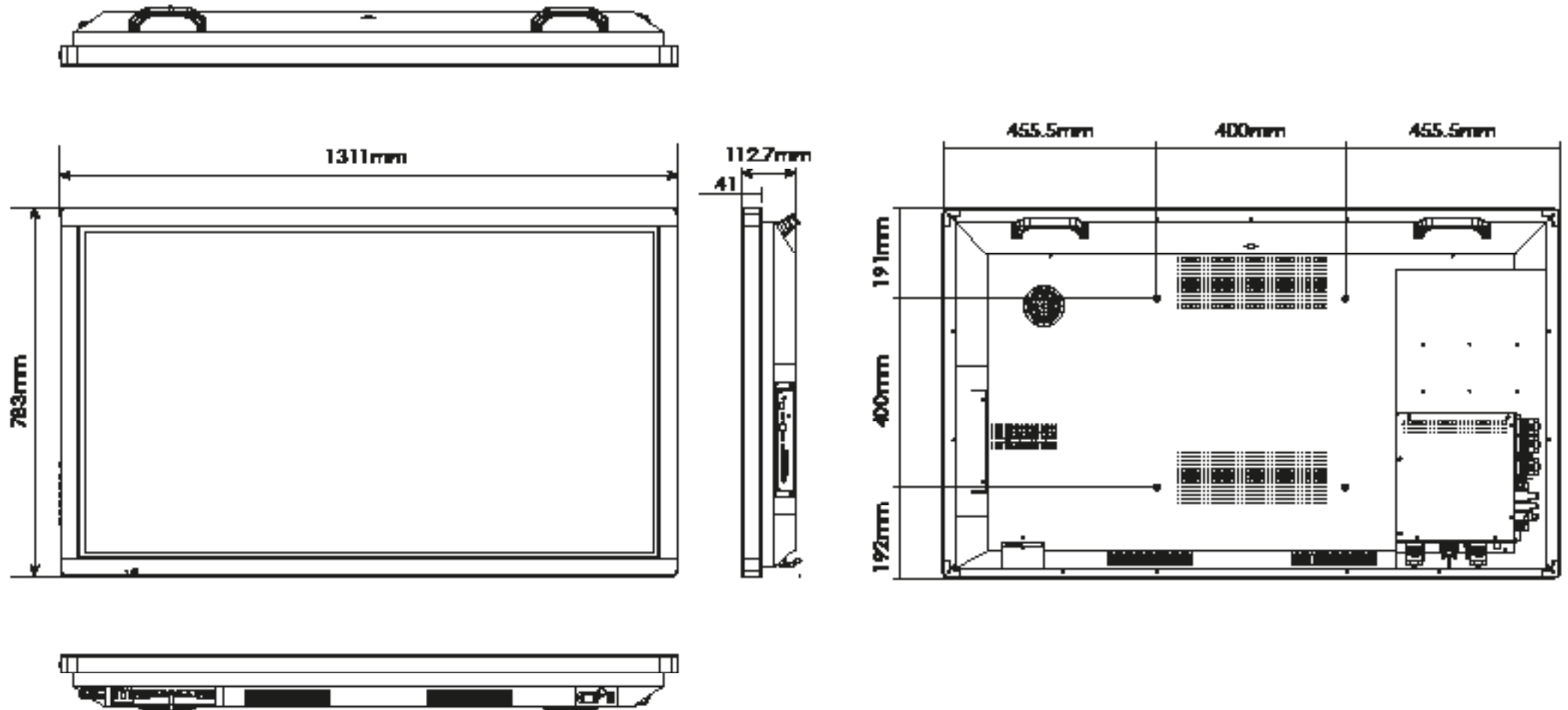

# 43" Lightning II Screen

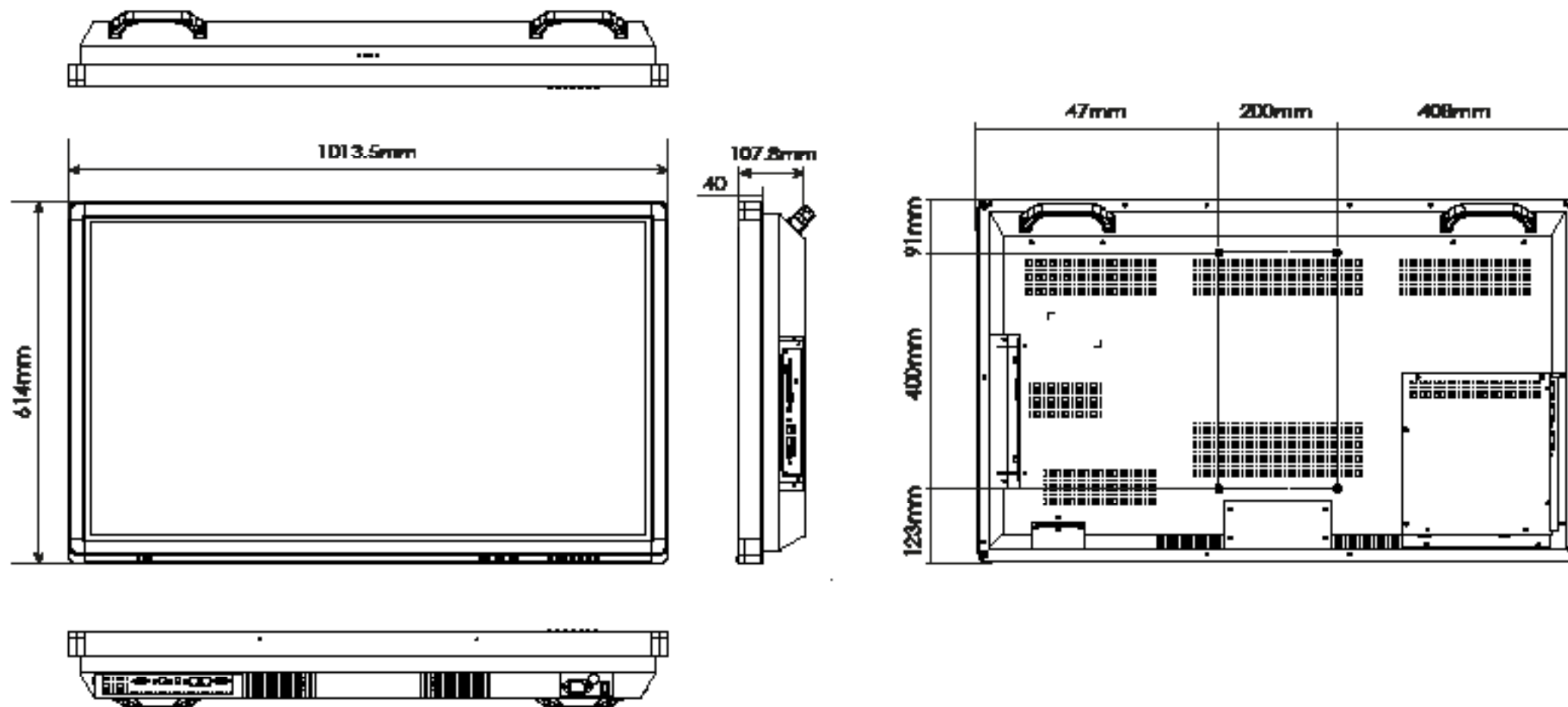



[promultis]

100 inch Touch Screen



[promultis]  
MULTITOUCH SOLUTIONS

For more exciting multitouch products visit  
[www.promultis.info](http://www.promultis.info)  
or call +44 (0) 239 251 2794

DISPLAY PANEL	
Screen Size	100" TFT-LCD
Display area	1241.3mm (H) x 2205.2mm (W) 16:9
Maximum Resolution	3840 x 2160 4K UHD
Display color	16.7M
Pixel Pitch(mm)	0.1845 (H) x 0.1845 (V)
Brightness (cd/m <sup>2</sup> )	350cd/m <sup>2</sup>
Contrast (Type)	2000 : 1
Visual angle	178°/178°
Response time	5ms
Life (hrs)	>60,000 (hrs)
TOUCH	
Detection Method	Infrared
Available Touch Point	20 Point
Response Time (Type)	<= 10 ms
Minimum Response Size	>= Φ3mm
Touch Resolution	32768 x 32768
Communication Interface	USB
MECHANICAL	
Monitor Size	2205.2mm (w) x 1374mm (h) x 115mm (d)
Colour	Black, white or silver
Case	Metal + Aluminium
Weight	145Kg

CONNECTIVITY	
HDMI	1
USB	2
VGA	1
Display Port	1
Composite video input	3 (BNCx3)
Speaker	2×5W(8Ω)
POWER	
Input Voltage	AC100 ~ 240V 50 /60 HZ
Maximum power consumption	<90W
Standby power consumption	<5W
TEMPERATURE	
Working temperature	0°C ~ 50°C
Storage temperature	-20°C ~ 60°C
Working humidity	85%
Storage humidity	85%
WARRANTY	
3 year on-site warranty as standard	
Extended warranties and SLA's available at an additional cost	

Note: Product design specifications including dimensions are subject to change without notice and may vary from those shown.



[promultis]

# 100 inch Touch Screen

