



[promultis]

totemfocus



## 55" 10 TOUCH TOTEM FOCUS INSTRUCTION MANUAL

PM-TOTEM2A/55/CAM

Before connecting, operating or adjusting this product,  
please read the manual completely.  
Please keep this manual for future reference.

# Contents

---

|                                     |           |
|-------------------------------------|-----------|
| <b>Important Information</b>        | <b>1</b>  |
| <b>Important Safety Precautions</b> | <b>2</b>  |
| <b>Identification of Controls</b>   | <b>4</b>  |
| <b>Remote Control</b>               | <b>6</b>  |
| <b>Connections</b>                  | <b>8</b>  |
| <b>Basic Operations</b>             | <b>11</b> |
| <b>Device Settings</b>              | <b>13</b> |
| <b>Network Settings</b>             | <b>14</b> |
| <b>Menu List</b>                    | <b>20</b> |
| <b>Using USB Multi Media Player</b> | <b>22</b> |
| <b>Troubleshooting</b>              | <b>26</b> |
| <b>Specifications</b>               | <b>27</b> |

## IMPORTANT INFORMATION

If the totem is not positioned in a stable location, it can be potentially hazardous due to falling. Many injuries, particularly to children, can be avoided by taking simple precautions such as:

- Use cabinets or stands recommended by the manufacturer of the totem.
- Only use furniture that can safely support the totem .
- Ensure the totem is not hanging over the edge of the supporting furniture.
- Do not place the totem on tall furniture (for example, cupboards or bookcases) without anchoring both the furniture and the totem to a suitable support.
- Do not position the totem on cloth or place any material between the totem and supporting furniture.
- Educating children about the dangers of climbing on furniture to reach the totem or its controls.
- Do not use immediately after moving from a low temperature to high temperature environment, as this causes condensation, which may result in fire, electric shock, or other hazards.
- To avoid possible condensation it is recommended to not use the device within 24 hours after its arrival, to avoid possible condensation.

### **Warning :**

**To prevent the spread of fire, keep candles or other open flames away from the totem all the times.**

# Important Safety Precautions

---

Electricity may cause personal injuries and property damage if improperly handled. The totem has been engineered and manufactured with the highest priority on safety. But IMPROPER USE CAN RESULT IN POTENTIAL ELECTRIC SHOCK OR FIRE HAZARD. In order to prevent potential danger, please observe the following instructions when installing, operating and cleaning the product. To ensure your safety and prolong the service life of your totem, please read the following precautions carefully before using the product.

- 1. Read these instructions**---All operating instructions must be read and understood before the product is operated.
  - 2. Keep these instructions**---These safety and operating instructions must be kept in a safe place for future reference.
  - 3. Note all warnings**---All warnings on the product and in the instruction manual must be observed closely.
  - 4. Follow all instructions**---All operating instructions must be followed.
  - 5. Attachments**---Only use attachments/accessories specified by the manufacturer. Do not use attachments which are not recommended by the manufacturer. Use of improper attachments can result in accidents.
  - 6. Power source**---This product is intended to be supplied with a listed power supply indicated on the marking label. If you are not sure of the type of power supply to your home, consult your product dealer or local power company. For added protection for this product during a lightning storm, or when it is left unattended and unused for a long period of time, unplug it from the wall outlet and disconnect the cable system.
  - 7. Power cord protection**---Protect the power cord from being walked on or pinched particularly at plugs, convenience receptacles, and the point where they exit from the apparatus.
- NOTE:** Where the mains plug or an appliance coupler is used as the disconnected device, the disconnected device shall remain readily operable.
- 8. Overloading**---Do not overload wall outlets, extension cords, or convenience receptacles on other equipment as this can result in a risk of fire or electric shock.
  - 9. Entering of objects and liquids**---Never insert an object into the product through vents or openings. High voltages are present in the product and inserting an object can cause electric shock and/or short internal parts. For the same reason, do not spill water or liquid on the product.
  - 10. Servicing**---Refer all servicing to qualified service personnel. Servicing is required when the apparatus has been damaged in any way, such as the power-supply cord or plug is damaged, liquid has been spilled or objects have fallen into the apparatus, the apparatus has been exposed to rain or moisture, does not operate normally or has been dropped.
  - 11. Damage requiring service**---If any of the following conditions occurs, unplug the power cord from the AC outlet and request a qualified service technician to perform repairs.
    - a. When the power cord or plug is damaged.
    - b. When liquid is spilled on the product or when objects have fallen into the product.
    - c. When the product has been exposed to rain or water.
    - d. When the product does not operate properly as described in the operating instructions.
    - e. If the product has been dropped or the cabinet has been damaged in any way.
    - f. When the product displays an abnormal condition or exhibits a distinct change in performance. Any noticeable abnormality in the product indicates that the product needs servicing.
  - 12. Replacement parts**---In case the product needs replacement parts, make sure that the service person uses replacement parts specified by the manufacturer, or those with the same characteristics and performance as the original parts. Use of unauthorized parts can result in fire, electric shock and/or other danger.
  - 13. Safety checks**---Upon completion of service or repair work, request the service technician to perform safety checks to ensure that the product is in proper operating condition.
  - 14. Wall or ceiling mounting**---When mounting the product on a wall or ceiling, be sure to install the product according to the method recommended by the manufacturer. This is a safety issue.

## Important Safety Precautions (Continued)

---

**15. Careful move**---When a trolley is used, be cautious when moving the trolley/apparatus combination to avoid injury from the product tipping over. Sudden stops, excessive force and uneven floor surfaces can cause the product to fall from the trolley.

Never attempt to move the totem unless the AC Power cord has been disconnected.

**16. Lightning**---Unplug this apparatus during a thunder storm or when unused for long periods of time.

**17. About location / environment**— Do not use in hot and cold rooms (locations).

- When the unit is used in rooms (locations) with low temperature, the picture may leave trails or appear slightly delayed. This is not a malfunction, and the unit will recover when the temperature returns to normal.
- Do not leave the unit in a hot or cold location. Also, do not leave the unit in a location exposed to direct sunlight or near a heater, or in high humidity, as this may cause the cabinet to deform and the screen to malfunction, and affect the totem's performance .
- Do not use immediately after moving from a low temperature to high temperature environment, as this causes condensation, which may result in fire, electric shock, or other hazards.
- Environment condition:
  - Operating temperature: 5°C – 35°C
  - Operating humidity: 20 – 80 % ( no moisture condensation )
  - Storage temperature: -15°C – 45°C
  - Storage humidity: 10 – 80 %
  - Atmospheric pressure: 86 kPa ~106 kPa

**18. Clean only with dry cloth**---Unplug this product from the wall outlet before cleaning. Do not use liquid cleaners or aerosol cleaners. Use a soft cloth for cleaning.

**19. Ventilation**---Do not block any ventilation openings. Install the totem in accordance with the manufacturer instructions. The vents and other openings in the cabinet are designed for ventilation. Do not cover or block these vents and openings since insufficient ventilation can cause overheating and shorten the life of the product.

**20. Panel protection**---The display panel used in this product is made of glass. Therefore, it can break when the product is dropped or impacted upon by other objects. Be careful not to be injured by broken glass pieces in case the display panel breaks.

**21. Pixel defect**---The display panel is a very high technology product, giving you finely detailed pictures. Occasionally, a few non-active pixels may appear on the screen as a fixed point of blue, green or red. Please note that this does not affect the performance of your product.

**WARNING:** For continued safety, apparatus with class I construction shall be connected to a mains socket outlet with a protective earthing connection.

### ***Environmental Protection***

Waste electrical products should not be disposed of with household waste. Please recycle where facilities exist. Check with your Local Authority or retailer for recycling advice.



# Identification of Controls

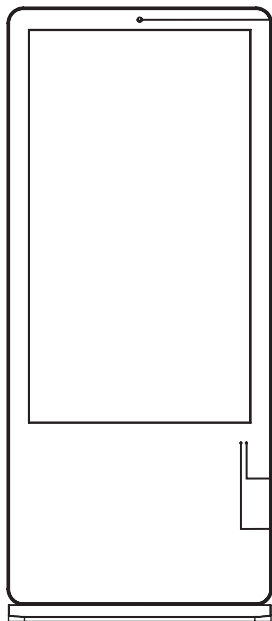

Camera

**Note:** It can perfectly support camera's up to 720p.

## ● Fastening the totem

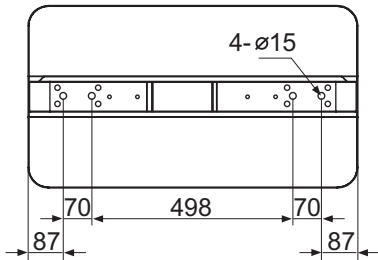

The totem must be secured to building structure before operation.

As illustrated in figure, positioning 4 holes on the earth and drill the holes at the corresponding position.

The diameter of the hole on the earth should be smaller than the diameter of the screw.

Fit the four fastening screws, fastening the totem to earth.

**Notes:** 1. The appearance of this product in these illustrations may differ from your actual product, and is for comparative purposes only.  
2. We may change the design and specifications without notice.

Power Indicator

Remote Sensor

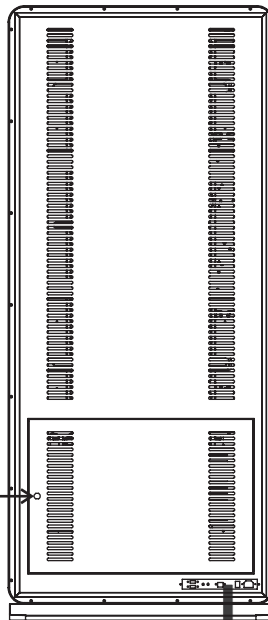

Open the back cover with the key.

**Note:** 1. Cut off power before opening the back cover.  
2. Make sure that the back cover is locked before turning on power.

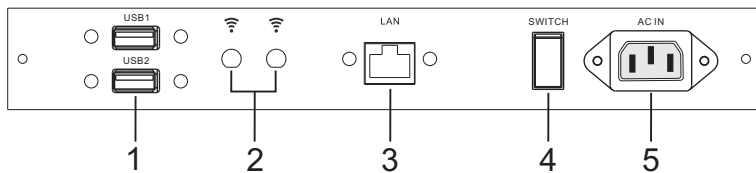

1. USB1/2 for the OPS

2. WiFi antenna for the OPS

3. LAN for the OPS

Enable connection to cable and log on to Internet.

**Note:** USB port, WiFi, LAN port is extended from the OPS, this port and the port on the OPS choose one to use.

4. Power Switch

Push to (I) to connect the power, push to (O) to cut off the power.

**Note:** Do not cover the Power switch, it should be kept free from coverings so that it can be easily and conveniently operated.

5. AC IN

Plug the AC cord into this jack and into a power outlet. (~100-240V 50Hz/60Hz)

# Identification of Controls

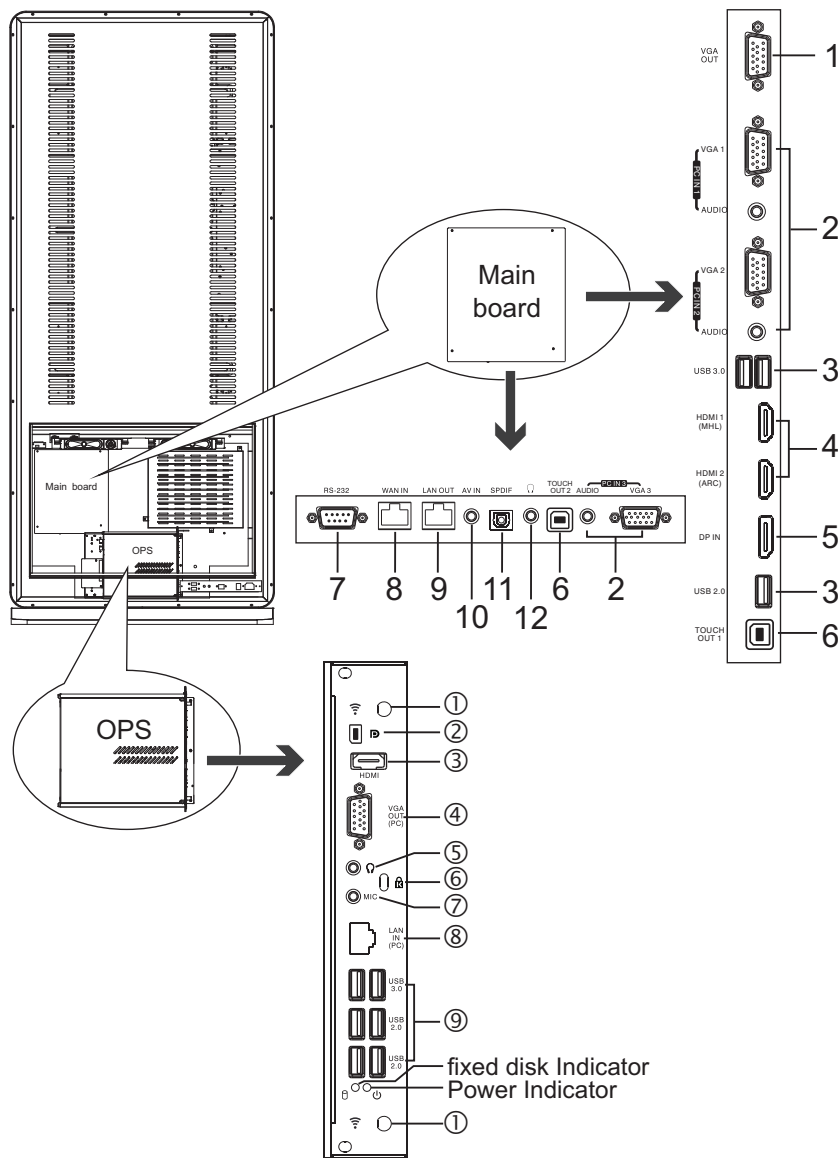

- ①. The OPS WIFI port for receiving network signal.
- ②. (DisplayPort)  
Enable connection to a monitor or other external devices with DisplayPort.
- ③. HDMI Output  
Enable connection to a monitor or other external devices with HDMI input port.
- ④. VGA OUT  
Enable connection to a monitor or other external devices with VGA input port.
- ⑤. Connect headphones to this jack. Audio output of the OPS.
- ⑥. The anti-theft lock groove.
- ⑦. MIC  
The microphone input of the OPS.
- ⑧. LAN IN  
Enable connection to cable and log on to Internet access via Cable.
- ⑨. USB2.0/3.0  
USB standard interface, enable connection to USB2.0, USB3.0 standard devices. Connecting, please select the appropriate port.

- 1.VGA OUT  
The currently selected PC IN 1/2/3 signal output.
- 2.PC IN1/2/3  
Enable connection to PC or other external devices with VGA/AUDIO ports.
- 3.USB2.0/3.0  
Connect USB devices to these ports.
- 4.HDMI1/2 Input  
To connect with those equipments with HDMI or DVI interface.  
HDMI1(MHL): Connect an MHL - enabled device such as a cell phone to this jack to view the external device's screen on your totem.  
HDMI2(ARC): Connect an ARC-enabled home theater receiver to this jack.
5. DP(DisplayPort) Input  
Connect an external device to DP out jack.
- 6.TOUCH1/2 OUT  
Output the touch for external devices connected to PCx or HDMIx port which support touch system.  
**Note:** TOUCH OUT 2 takes precedence over TOUCH OUT 1 in default. You can define it to in Lock menu.
- 7.RS232  
For service, RS232 control and the other uses.
- 8.WAN IN  
The built-in router input port. Connect to the external network.
- 9.LAN OUT  
The built-in router output port. Connection to another computer or other Internet enabled devices.
- 10.AV IN  
Connect an AV device to this jack.
- 11.S/PDIF digital audio output  
Connect a digital sound system to this jack.
12. Connect headphones to this jack. The totem is the current audio output.

# Remote Control

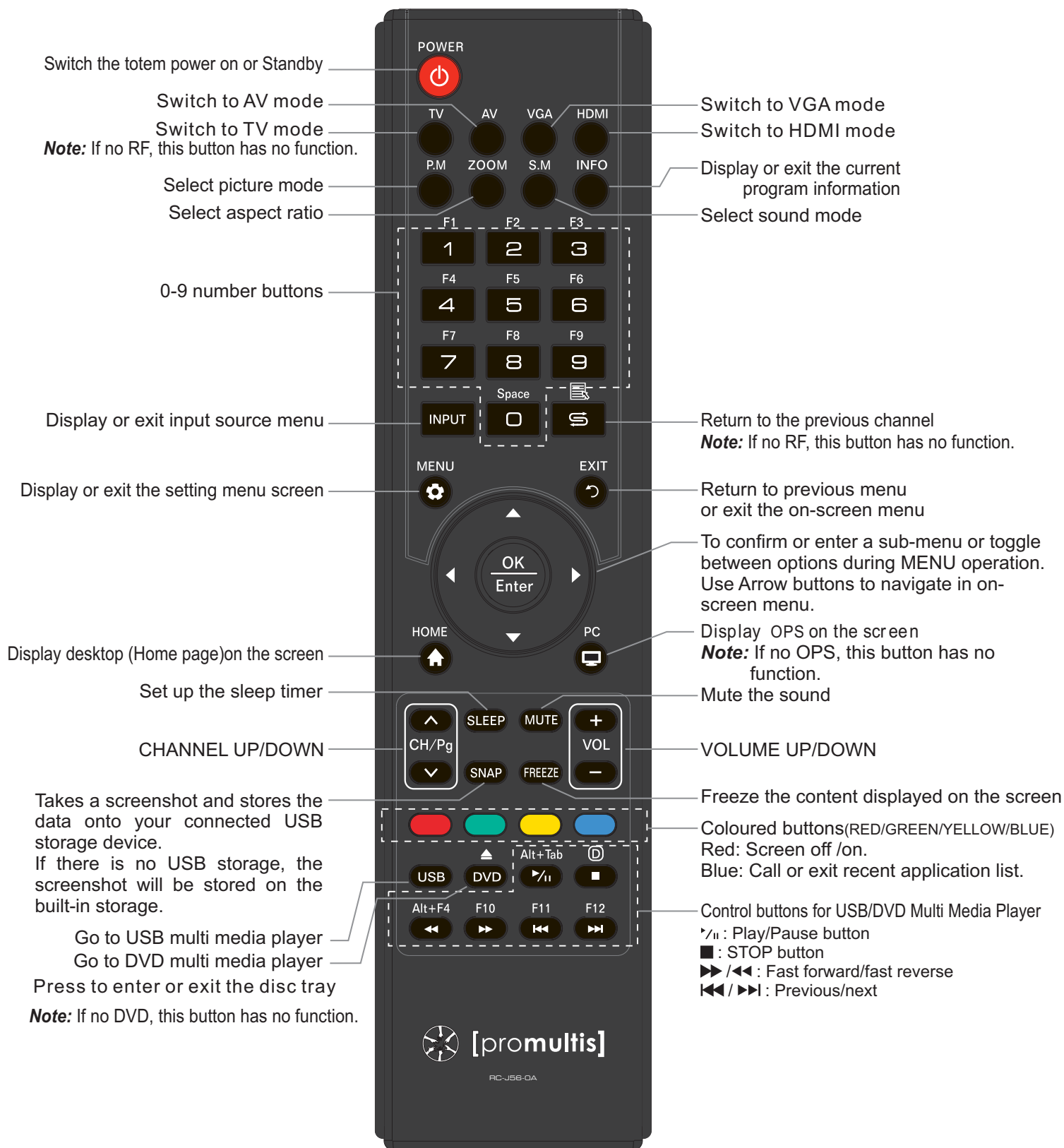

**Notes:**

- This operation manual provides a description based on operating functions with the remote control.
- In different mode, some buttons may have different function.



# Remote Control

---

## **Installing remote control Batteries**

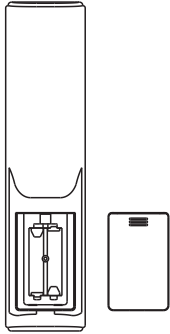

### **To install remote control batteries:**

- 1 Open the battery cover.
- 2 Insert two AAA batteries into the battery compartment. Make sure that the + and – symbols on the batteries match the + and – symbols in the battery compartment.
- 3 Replace the cover.

### **Battery precautions:**

Improper use of batteries can result in a leakage of chemicals and/or explosion. Be sure to follow the instructions below.

- Place batteries with their terminals corresponding to the (+) and (–) indications.
- Different types of batteries have different characteristics. Do not mix batteries of different types.
- Do not mix old and new batteries. Mixing old and new batteries can shorten the life of new batteries and/or cause old batteries to leak chemicals.
- Remove batteries as soon as they are non-operable. Chemicals that leak from batteries can cause a rash. If chemical leakage is found, wipe with a cloth.
- Dispose of batteries in a proper manner.
- If the remote control is not used for an extended period of time, remove the batteries.
- The batteries shall not be exposed to excessive heat such as sunshine, fire or the like.

---

## **Aiming the remote control**

Use the remote control by pointing it towards the remote sensor on the front of your totem. Objects between the remote control and the remote sensor may prevent proper operation.

### **Cautions regarding use of remote control**

- Do not expose the remote control to shock. In addition, do not expose the remote control to liquids, and do not place in an area with high humidity.
- Do not install or place the remote control under direct sunlight. The heat may cause deformation of the unit.
- The remote control may not work properly if the remote sensor window of the main unit is under direct sunlight or strong lighting. In such a case, change the angle of the lighting or the totem set, or operate the remote control closer to the remote sensor window.

# Connections

## Cautions Before Connecting

- When connecting an external device to the totem, make sure that the totem and the device are turned off.
- Check the plugs at the ends of cables to make sure that they are the correct type before you try plugging them into jacks on the totem.
- Make sure that all plugs are securely inserted into the jacks. Loose connections can result in image or color problems.
- The illustration of the external device may be different depending on your model.
- Refer to the operating manual of the external device as well.

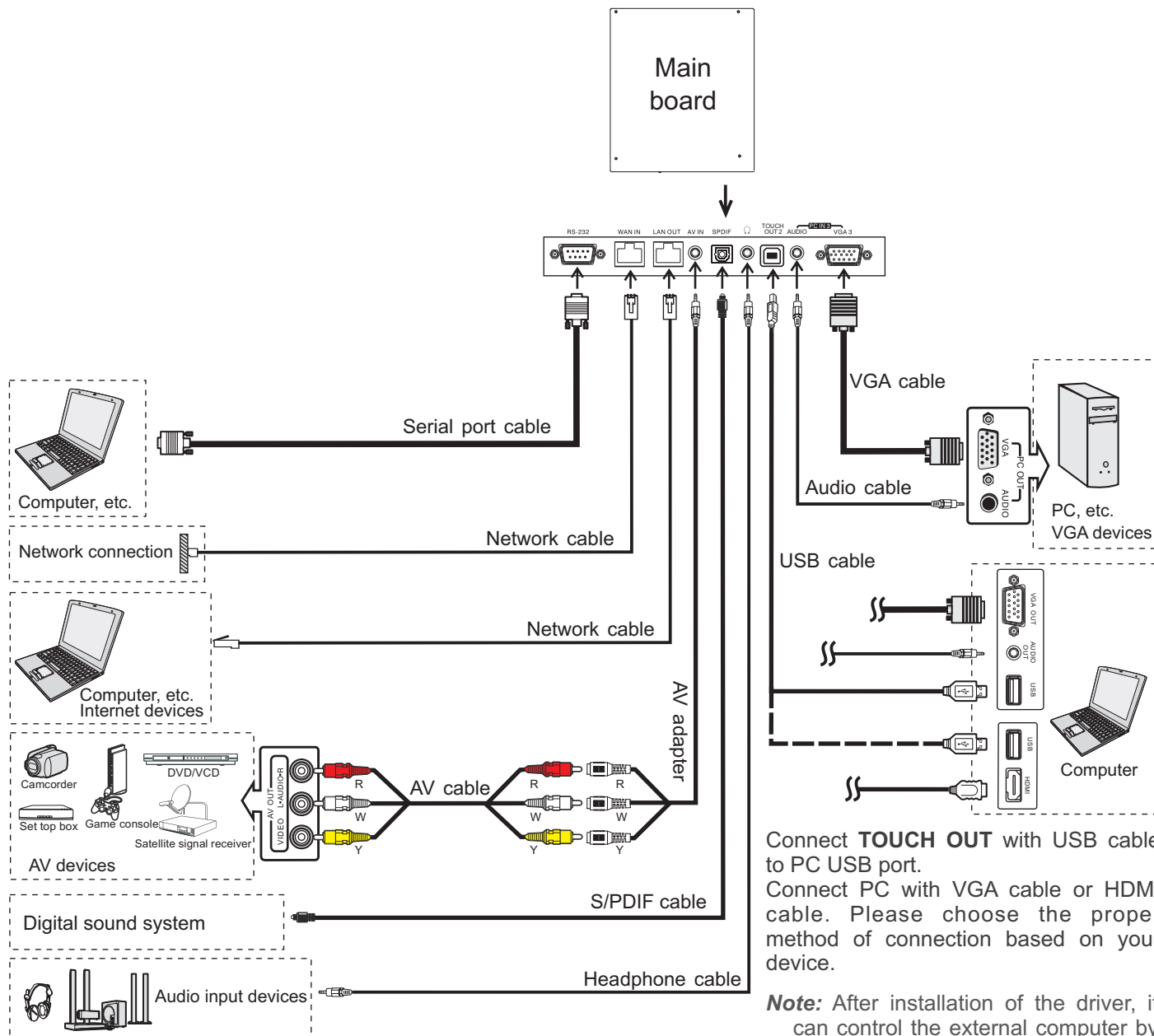

**Note:** Before using headphones, adjust the device volume so as to avoid excessive levels, as hearing damage may result.

Connect **TOUCH OUT** with USB cable to PC USB port.  
 Connect PC with VGA cable or HDMI cable. Please choose the proper method of connection based on your device.

**Note:** After installation of the driver, it can control the external computer by native touch control. (Only for PC, HDMI signal)  
 TOUCH OUT 2 takes precedence over TOUCH OUT 1 in default. You can define it to in Lock menu.

# Connections

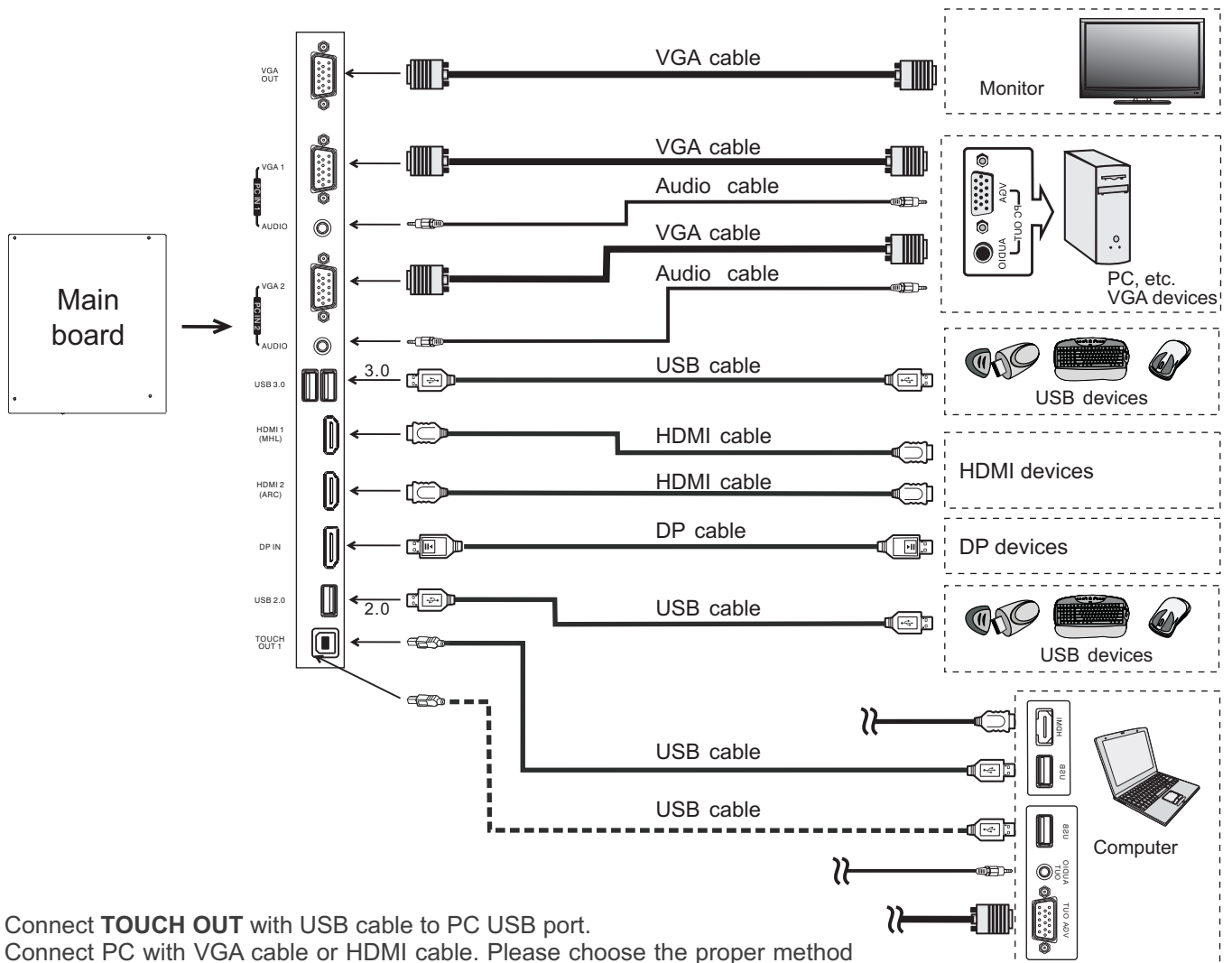

Connect **TOUCH OUT** with USB cable to PC USB port.  
 Connect PC with VGA cable or HDMI cable. Please choose the proper method of connection based on your device.

**Note:** After installation of the driver, it can control the external computer by native touch control. (Only for PC、HDMI signal)  
 TOUCH OUT 2 takes precedence over TOUCH OUT 1 in default. You can define it to in **Lock** menu

- ⓘ **Notes:** 1.The totem is multiple USB port designed(3.0, 2.0), when connect with USB device, please select the appropriate port.  
 2.The VGA output is signal of what has been currently selected from PC1/2/3.

# Connections

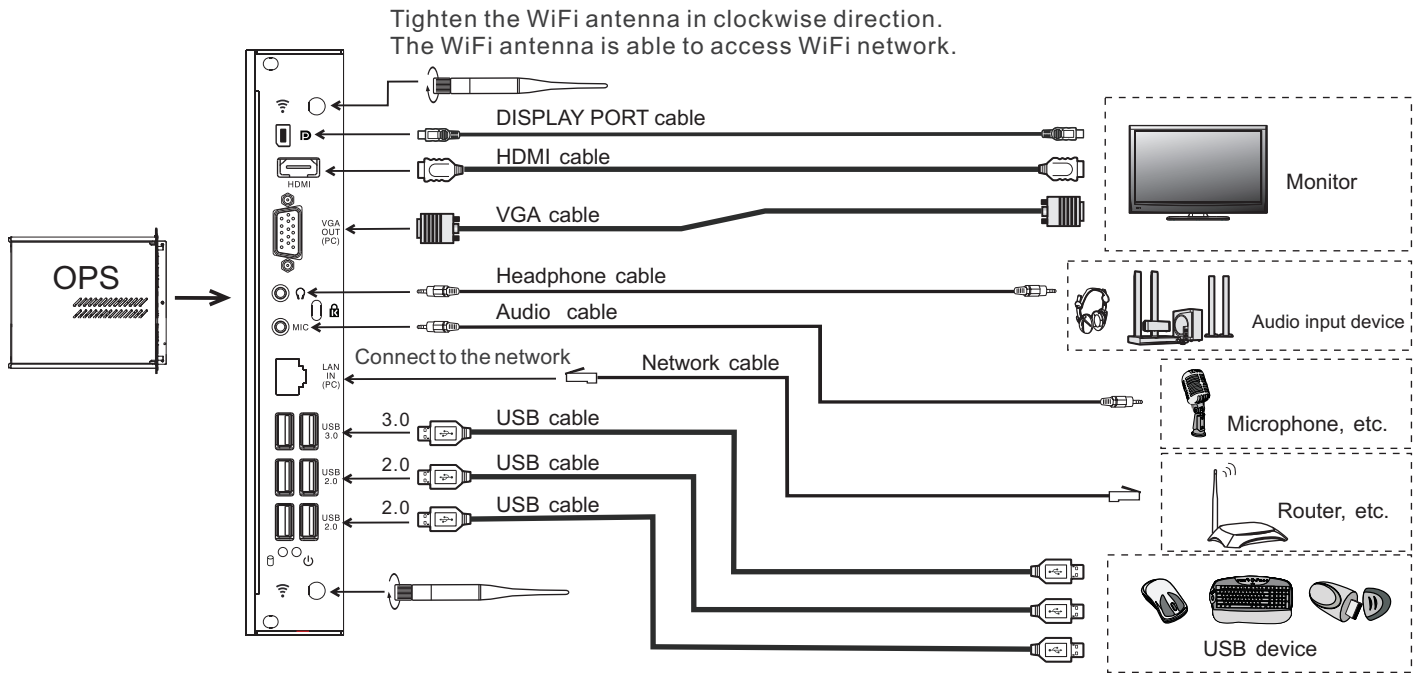

- ⓘ **Notes:**
1. The OPS is multiple USB port designed(3.0, 2.0), when connect with USB device, please select the appropriate port.
  2. The signal of Audio or Video output are OPS generated.

# Basic Operations

## Turning the totem on or off

- 1 Plug the power cord into an AC Power outlet. Press **Power Switch** on the totem.
- 2 Now the totem is in standby mode. Wait a moment until the power indicator lights up, then press **POWER** ⏻ to turn on the totem. (Be sure to wait for a few seconds before pressing POWER button. If you promptly press POWER button then the totem may not respond or act wrongly.)
- 3 Press ⏻ button again to turn off the totem and put the totem in standby mode.  
To cut off the power completely, press **Power Switch** on the totem.

**Note:** If the totem does not receive a displaying signal for a certain time, the totem goes into standby mode.

## The first time installation

Connect to power source and turn on the totem, the below installation menu page will display on the totem.



Select desired menu language, then press **START** and go to next page.

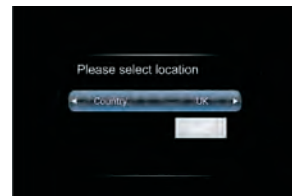

Select location and go to next page.

## Operating the Float menu

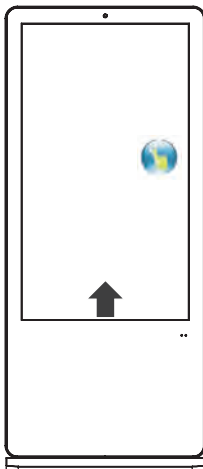

1. Slide up from bottom of the screen center by two or more fingers to call .  
Press and drag to any place of the screen.
2. Press to take 2 seconds to be activated in VGA/HDMI/DP/PC mode.
3. When displaying at USB interface, touch once at the lower part of the screen, the display control menu will appear.

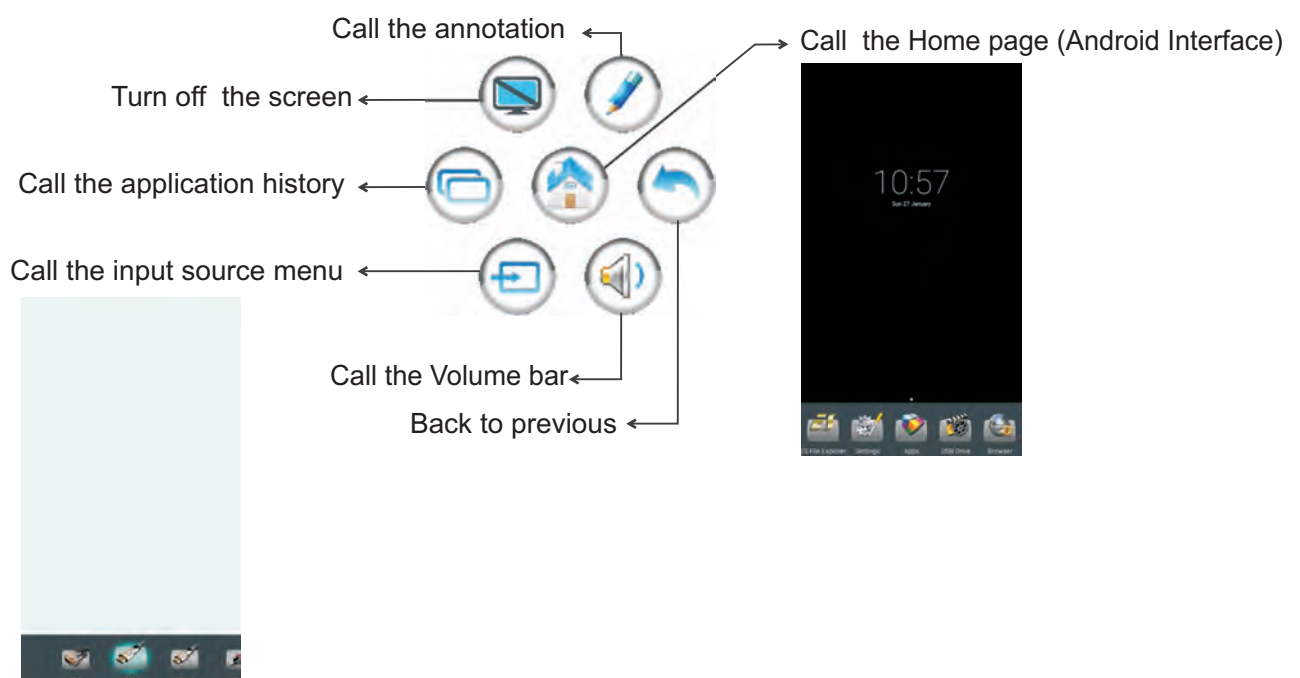

# Basic Operations(Continued)

## Home Menu Overview

Shortcuts you created on Home page

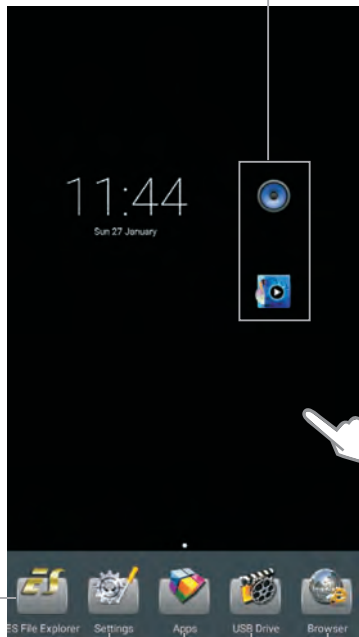

In all applications, press and drag the icon to on Home page for shortcut created, press and drag the shortcut to X for shortcut deleted.

Long press on the screen will call the wallpapers and widgets menu.



ES File Explorer

Call the device **Settings** menu

Go to your **web Browser**

Go to your **USB Drive**

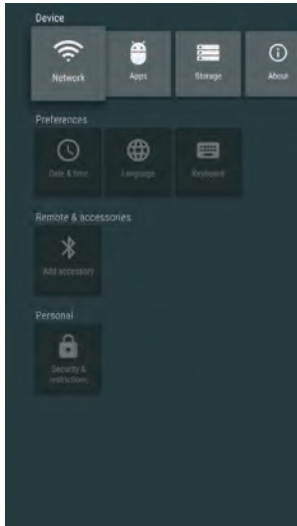

Show all applications



**Note:** When using the app Camera, store the data onto your connected USB device. If USB device is not connected, store the data onto the built-in storage.



**Note:** The layout of menu may vary upon different models you purchased.

# Device Settings

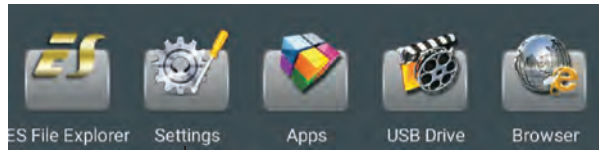

Network Setting   Show all apps   Display system Storage

Device

- Network
- Apps
- Storage
- About

Preferences

- Date & time
- Language
- Keyboard

Remote & accessories

- Add accessory

Personal

- Security & restrictions

Display information of the unit

To set on-screen language

To set default input method  
To set Android keyboard(AOSP)

To set Date and time

**Note:** To manually set date and time, you should toggle **“Automatic Date & time”** to **OFF**.

Automatic search for Bluetooth devices

To set Security and Restrictions  
Allow installation of apps from sources other than the Play Store.

# Network Settings

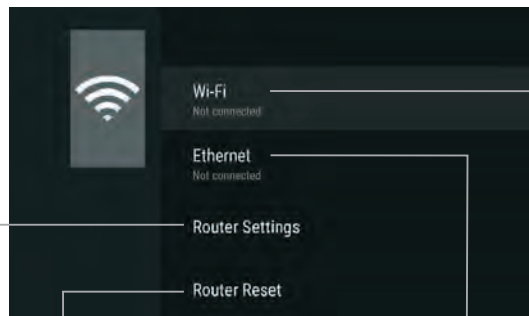
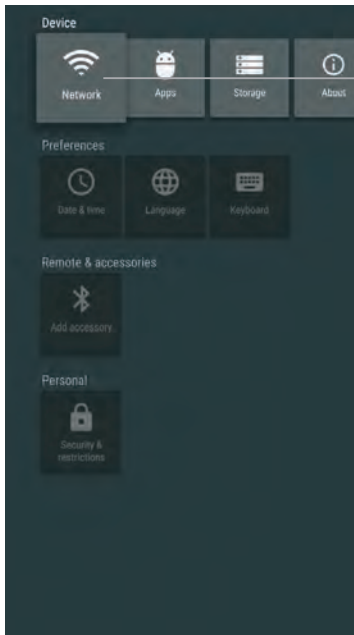
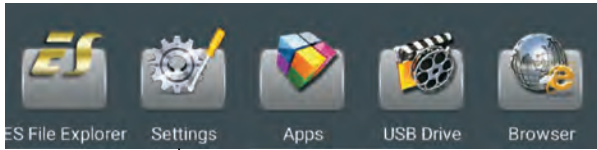

Set the Built-in WiFi

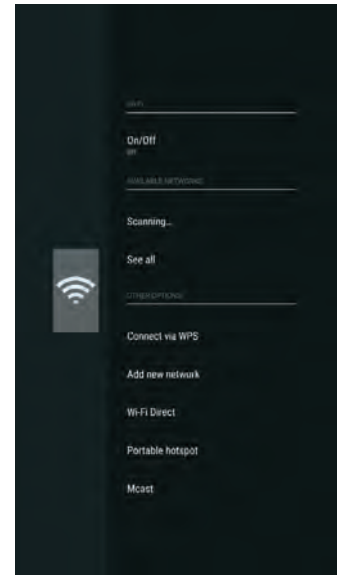

Reset Internal Router by hardware. Password is required for this operation and is the same password to access Lock menu. (The default password is 0000)

Internal routing setting



Input the default UserName: **admin**, skip the default password setting as there is no default password, then press **Login** button.

Ethernet setting

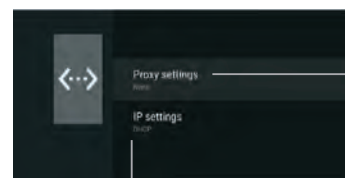
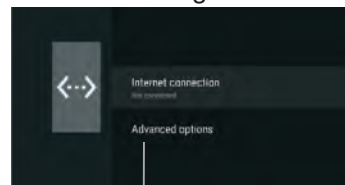

IP settings

Proxy settings



Change the UserName and Password: Select **Management**, then **Password**.

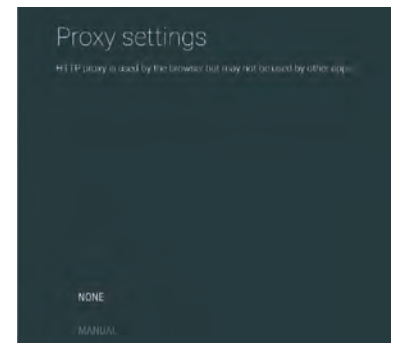
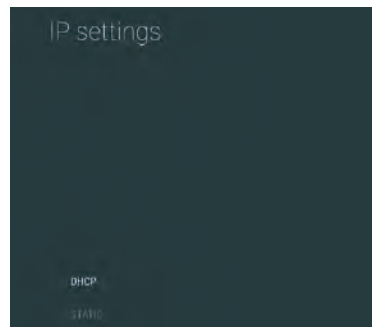



# Network Settings(Continued)

## Wired Network Setting (Internal router) Method 1: Easy Setup Wizard

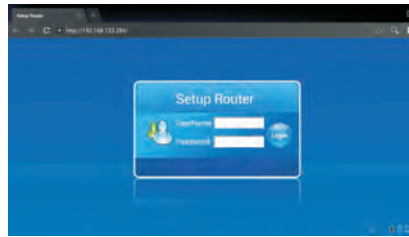

Input the default Username: **admin**, skip the default password setting as there is no default password, then press **Login** button.



Select **Gateway**

Select **Easy Setup Wizard**

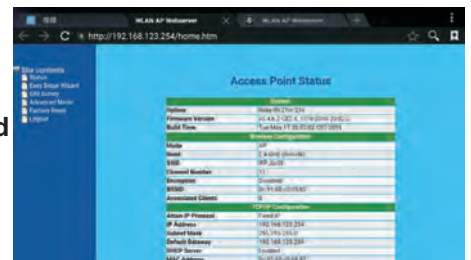

Next

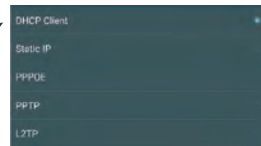
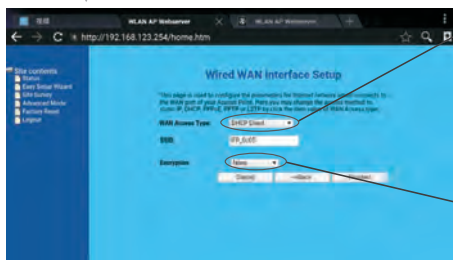

Password Setting Format



There are five methods to connect with network, choose your preferred one. Recommended to select the **DHCP Client** connection. Automatically obtain IP information from your ISP.

**DHCP Client:**Automatically obtain IP information from your ISP. If your ISP doesn't provide a designated IP for you, then choose DHCP Client.

**Static IP:** If all Internet IP information is provided by your ISP, then choose Static IP.

**PPPOE:** Ethernet Point to Protocol. Your ISP will provide you with Login ID and password. Usually this option is applicable to DSL service.

**PPTP:** Point to Point Tunneling Protocol. Your ISP will provide you with Login ID and password.

**L2TP:** Layer 2 Tunneling Protocol. Your ISP will provide you with Login ID and password. Usually this option is applicable to DSL service.

Finished

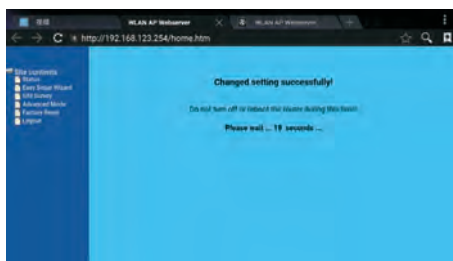

WiFi Password of Internal Router in the totem. (Password should be set at least 8 characters. )

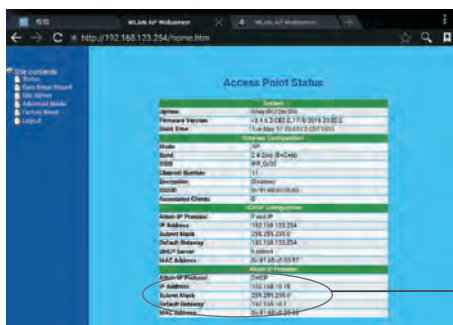

Get IP address Setting successfully

# Network Settings(Continued)

## Wired Network Setting (Internal router) Method 2: Advanced Mode

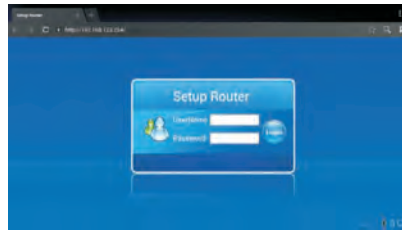
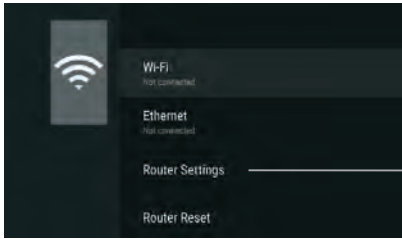

Input the default Username: **admin**, skip the default password setting as there is no default password, then press **Login** button.

Select Setup Wizard

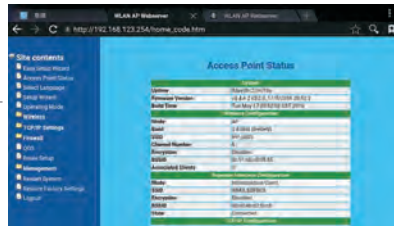

Select Advanced Mode

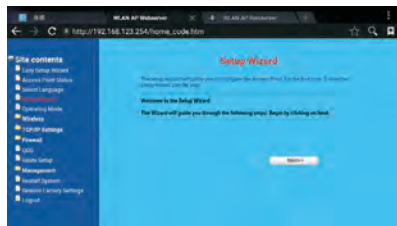

Next



Select Gateway  
Next

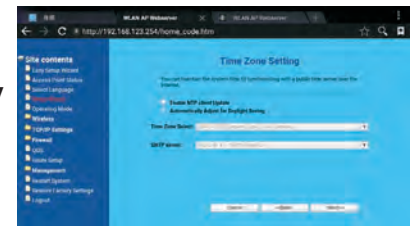

Next

Recommended to select AP

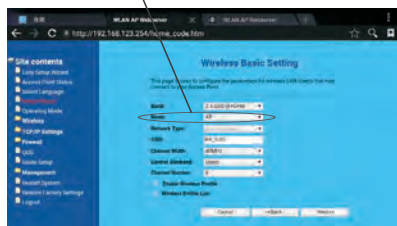

Next



Next



Next



Password Setting Format

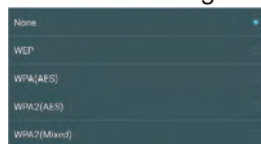

WiFi Password of Internal Router in the totem. (Password should be set at least 8 characters.)

There are five methods to connect with network, choose your preferred one. Recommended to select the **DHCP Client** connection. Automatically obtain IP information from your ISP.

Finished

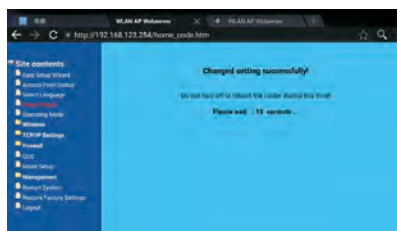

Next



Get IP address Setting successfully

# Network Settings(Continued)

## Wireless Network Setting (Internal router) Method 1: Easy Setup Wizard

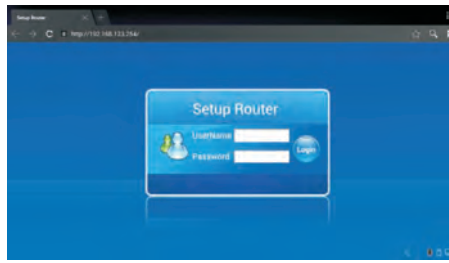

Input the default Username: **admin**, skip the default password setting as there is no default password, then press **Login** button.



Select **Wireless ISP**  
Next

Select **Easy Setup Wizard**

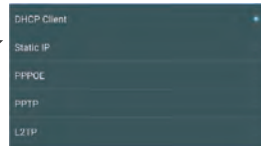
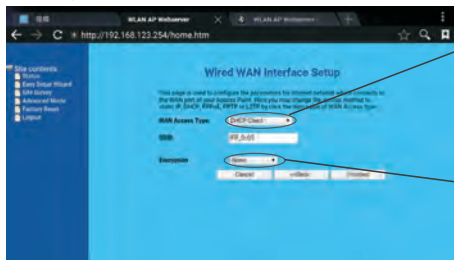
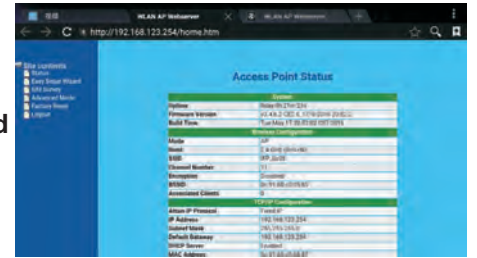

There are five methods to connect with network, choose your preferred one. Recommended to select the **DHCP Client** connection. Automatically obtain IP information from your ISP.

Password Setting Format



WiFi Password of Internal Router in the totem. (Password should be set at least 8 characters.)

Finished

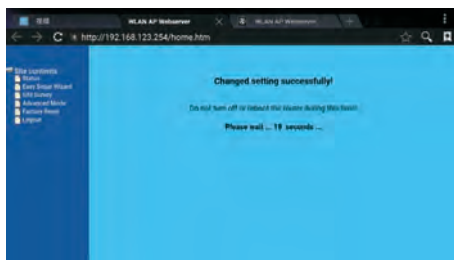

Successfully connected to return.  
Select **Site Survey**



Confirm **Site Survey**



Input Password  
Connect

Select your desired WiFi signal.

Next



Get IP address  
Setting successfully

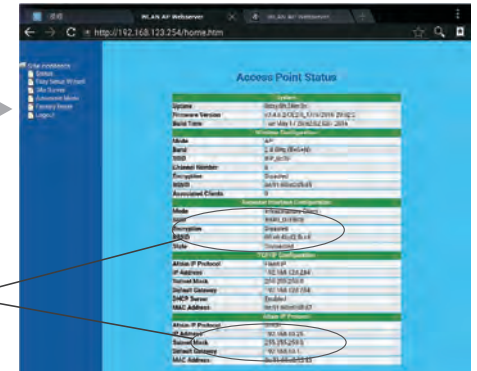



# Network Settings(Continued)

## Wireless Network Setting (Built-in WiFi card)

The image illustrates the steps to access wireless network settings on an Android device. It consists of three sequential screenshots:

- Top Screenshot:** The main settings menu. The 'Network' icon (a Wi-Fi symbol) is highlighted with a white arrow pointing to the second screenshot.
- Middle Screenshot:** The 'Network' settings page. The 'Wi-Fi' option (with a Wi-Fi symbol and 'Not connected' status) is highlighted with a white arrow pointing to the bottom screenshot.
- Bottom Screenshot:** The 'Wi-Fi' settings page. This page contains several options, each with a white arrow pointing to a descriptive text label on the right:
  - On/Off** (off): Turn on or off the built-in WiFi
  - See all**: Display all of the WiFi sites available
  - Connect via WPS**: Connect to WPS (WiFi Protected Setup) router
  - Add new network**: Add a new network manually
  - Wi-Fi Direct**: Scanning WiFi direct device
  - Portable hotspot**: Setting Portable WiFi hotspot
  - Mcast**: Setting Mcast

# Menu List

## Adjusting Picture mode



|                   |   |   |                                    |
|-------------------|---|---|------------------------------------|
| Picture           | Picture Mode  | Select your favourite picture mode for each input <b>[Standard]</b> / <b>[Soft]</b> / <b>[User]</b> / <b>[Game]</b> / <b>[Writing]</b> / <b>[Dynamic]</b> . |                                    |
|                   | Contrast  | Adjust the contrast.  |                                    |
|                   | Brightness  | Adjust the brightness.  |                                    |
|                   | Hue   | Adjust the image hue. (Only for NTSC system)  |                                    |
|                   | Sharpness   | Adjust the sharpness.   |                                    |
|                   | Saturation  | Adjust the color saturation.  |                                    |
|                   | Backlight   | Set up the overall brilliance of the screen.  |                                    |
|                   | Energy Save   | The backlight brightness is decreased.  |                                    |
|                   | Screen  | Clock   | Adjust the screen size.            |
|                   |   | Phase   | Adjust the focus of stable images. |
| H-Position        |   | Move the image right or left.   |                                    |
| V-Position        |   | Move the image up or down.  |                                    |
| Auto Adjust       |   | Automatically adjust the image settings such as position and phase.   |                                    |
| Color Temperature | Select the color temperature.<br>If you select <b>User</b> , you can set the level of the Red/Green/Blue as your desired. |   |                                    |
| Zoom Mode         | Select the aspect ratio (display proportions) according to your video signal type or personal preference.                 |   |                                    |
| OverScan          | Adjust the reproduction ratio, you may activate this function to obtain a cleaner picture.                                |   |                                    |
| Image NR          | Turn on/off the noise reduction mode to reduce picture noise.   |   |                                    |

## Adjusting Sound mode



|       |                                       |   |
|-------|---------------------------------------|---|
| Sound | Sound Mode                            | Select your favourite sound mode for each input <b>[Standard]</b> / <b>[Music]</b> / <b>[Movie]</b> / <b>[Sports]</b> / <b>[User]</b> .   |
|       | Bass                                  | Adjust Bass (low sounds) .  |
|       | Treble                                | Adjust Treble (high sounds).  |
|       | Balance                               | Adjust volume level of right and left speakers.   |
|       | AVC                                   | Select <b>[On]</b> to equalize overall volume levels across all channels.<br>Select <b>[Off]</b> to turn off the auto volume control.   |
|       | Surround                              | Turn the Surround sound effect on or off.   |
|       | SPDIF Output<br>(digital signal only) | Select the digital audio output mode for S/PDIF.<br>Select <b>[RAW]</b> to output audio signal as its original format.<br>Select <b>[PCM]</b> to output audio signal by PCM format. |
|       | SPDIF Volume                          | Adjust SPDIF volume.  |
|       | Alone                                 | Turn off the picture on your monitor and listen to the program audio only.<br>Wake up by any key or touch with two or more fingers.   |

# Menu List

## Adjusting Setting menu



|         |                    |  |
|---------|--------------------|--|
| Setting | Source Auto Switch | Select <b>On</b> to automatically recognition source.  |
|         | Color Range        | Select color range. (Only for HDMI mode)   |
|         | MHL Auto Switch    | Select <b>On</b> to automatically switch to the MHL input when it connected.   |
|         | HDMI_ARC           | Select <b>On</b> to turn on enable HDMI_ARC.   |
|         | Movie Mode         | Turn on/off the movie mode.  |
|         | Menu Timeout       | Select OSD menu display time.  |
|         | Date / Time        | Display Date and Time.   |
|         | Off Timer          | Set Off timer to switch the totem to standby at a specified time.  |
|         | On Timer           | Set On timer to turn on the totem automatically to source at a certain time.   |
|         | Sleep Time         | Set the duration of time until the totem automatically goes into Standby mode.<br><b>[Off] / [10 Minutes] / [20 Minutes] / [30 Minutes] / [60 Minutes] / [90 Minutes] / [120 Minutes] / [180 Minutes] / [240 Minutes].</b> |

## Adjusting Lock menu



The default password is 0000.

|                    |   |  |  |
|--------------------|---|--|--|
| Lock               | Lock System                             | Select <b>Off</b> to in the <b>Lock System</b> menu to unlock it.<br>Select <b>Lock Touch</b> to disable the function of the touch panel.  |  |
|                    | Float Menu                              | Turn on/off the float menu display.  |  |
|                    | F.M Auto Off                            | Enable the float menu auto off if there is no activity for 15 secs or not.   |  |
|                    | Set Password                            | Password settings.   |  |
|                    | Change Logo                             | Set logo<br><b>Note:</b> Before setting the logo, save the logo picture (should be "JPEG" format and size <512KByte) you want to use on root of USB disk and named "boot0.jpg". Insert the USB disk into the USB port on the Android board.                    |  |
|                    | Power on Source                         | Power on Source Setting, in <b>MEMORY</b> mode, when the totem powered on, it will automatically switch to the source when it powered off last time. otherwise, it is in setting mode.   |  |
|                    | Power on Volume                         | Power on Volume Setting.<br>In <b>Memory</b> mode, when the totem powered on, volume will same as the power off.   |  |
|                    | Volume Settings                         | In <b>Settings</b> mode, every time the totem turns on, volume is the value of this setting.   |  |
|                    | InputLabel                              | Source   | Select the input source you want to label.   |
|                    |   | Label  | Edit the label of the selected input source. |
|                    |   | Reset  | Reset labels to defaults.                    |
|                    | TouchOut1 To                            | TouchOut is there to define which touch signal output belong to which input. E.g. If TouchOut1 is set to VGA1 it means the touch signal output from TouchOut1 belongs to the input from VGA1. When both ports are connected TouchOut2 has priority by default. |  |
|                    | TouchOut2 To                            |  |  |
|                    | Wake up by gesture                      | Select <b>On</b> to enable two or more fingers touch the bottom of the screen and drag upward to turn on the totem when the totem is in standby mode.  |  |
| Restore To Default | Reset all settings to factory defaults. |  |  |

# Using USB Multi Media Player

## Using USB multi media player

You can connect a USB storage device to your totem to view compatible photo, movie or play compatible music so that the sound can be output from the totem's speaker.

To use USB multi media player, please go to USB source by pressing **USB** button. Or you can press **Home** button to display Home Page and then select **USBDrive** icon to access.

### Notes:

- Never remove the USB storage device or turn off the totem while using the USB storage device.
- It is recommended that you back up your USB device data.
- Your totems USB menu may look different to the interface shown in this manual.
- If you want to pull out the USB device, please exit USB mode first. For instructions on using your USB device, refer to the user's manual of your USB device.
- Please name your files in English. Otherwise the file names can not be shown correctly.
- Certain types of USB device may not be compatible with this totem.

## USB multi media interface introduction

To select and play files from different sources.  
(you can select from local disk device (USB device),  
network SAMBA device)

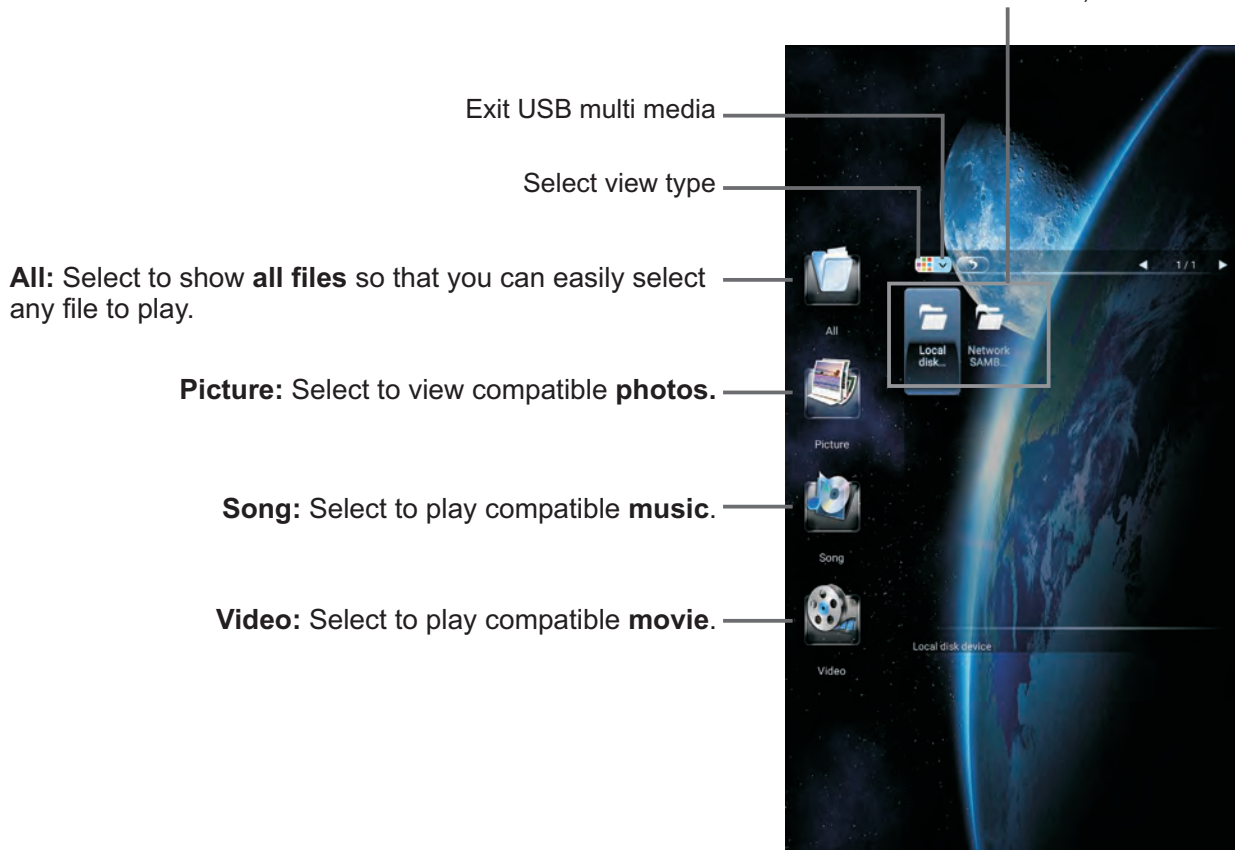



# Using USB Multi Media Player

## *Playing Photo*

With the photo viewer, you can view compatible photos (in JPG, BMP or PNG format). Also you can zoom, rotate photo, etc.



**Note:** You can also use  $\blacktriangle/\text{II}$  (Play/Pause),  $\blacksquare$  (STOP),  $\lll$  (Previous),  $\ggg$  (Next) on the remote control to operate.



# Using USB Multi Media Player

## Playing Music

With the USB music player, you can play compatible music (in MP3 or AAC format).



- Previous song
- Pause/Play
- Next song
- Repeat mode select
- Select sound mode
- Show information
- Show playlist

 repeat to play single music,  repeat to play all music files in current folder when it plays to the end,  no repeat when it plays to the end.

**Note:** You can also use  (Play/Pause),  (STOP),  (Previous),  (Next) on the remote control to operate.

# Using USB Multi Media Player

## Playing Movie

With the USB movie player, you can play compatible movie (in MPG, MKV, DAT, MP4, MOV or VOB format).



Previous movie  
Fast reverse  
Play/pause  
Fast forward  
Next movie

Skip to specific point by input time

Current time : 00:00:20  
Total time : 00:05:53  
00:00:00

Show playlist  
Show information

Adjust the volume  
AB Section repeat

Playing settings

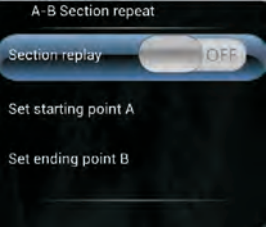
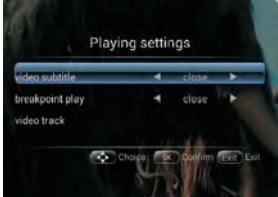

Now AB repeat starts. To cancel, highlight **Section replay** and toggle it to **OFF**.

# Troubleshooting

If, after reading these operating instructions, you have additional questions related to the use of your totem, please call the services center in your local area.

Before calling service, please check the symptoms and follow suggested solutions.

## Remote Control

| <i>Problem</i>                  | <i>Possible Solutions</i>   |
|---------------------------------|---|
| Remote control does not operate | <ul style="list-style-type: none"><li>• The batteries could be weak. Replace the batteries.</li><li>• Check the orientation of the batteries.</li><li>• Make sure the power cord is plugged in.</li></ul> |

## Video and Audio

| <i>Problem</i>                                       | <i>Possible Solutions</i>  |
|--|--|
| No picture (screen not lit),<br>No sound             | <ul style="list-style-type: none"><li>• Make sure the power cord is plugged in.</li><li>• Press POWER on the totem or on the remote control.</li></ul>   |
| Dark, poor or no picture<br>(screen lit), good sound | <ul style="list-style-type: none"><li>• Select a proper picture mode.</li><li>• Adjust the brightness in the video setting.</li></ul>  |
| No color/dark picture/abnormal color                 | <ul style="list-style-type: none"><li>• Adjust the color saturation in the video setting.</li></ul>  |
| Good picture, no sound                               | <ul style="list-style-type: none"><li>• The sound may be muted. Press MUTE again to cancel.</li></ul>  |
| Audio noise  | <ul style="list-style-type: none"><li>• Communication problems may occur if infrared communication equipment (e.g., infrared cordless headphones) is used near the totem. Move the infrared communication equipment away from the totem until the noise is eliminated.</li></ul> |

## General

| <i>Problem</i>   | <i>Possible Solutions</i>  |
|--|--|
| Some items can't be accessed                           | <ul style="list-style-type: none"><li>• If a setting option appears in gray, this indicates that the settings option is unavailable in current input mode.</li></ul>   |
| Effect pressed on the remote control is not applied.   | <ul style="list-style-type: none"><li>• When the totem is detecting attached USB devices or when you initially plug in a USB device the totem may not respond to the remote control, please wait for a few moments then try again.</li></ul> |
| POWER button responds slowly after power is connected. | <ul style="list-style-type: none"><li>• When you push POWER SWITCH to power on the totem, in about 3 seconds the POWER button starts to respond after pressed.</li></ul>   |

**Note:** If your problem is not solved, turn your unit off and then on again.

**Cautions:** Never attempt to repair a defective totem yourself.

# Specifications

|   |                            |  |
|---|----------------------------|--|
| <b>Model No.</b>                              |                            | PM-TOTEM2A/55/A  |
| <b>Power Source</b>                           |                            | AC 100-240 V, 50 / 60 Hz   |
| <b>Power Consumption</b>                      | <b>Current Max.</b>        | 2.4 A  |
|   | <b>Standby condition*</b>  | < 0.5 W  |
| <b>Display panel</b>                          | <b>Number of pixels</b>    | 1,920 (W) × 1,080 (H)  |
|   | <b>Visible screen size</b> | 55 inches(diagonal)  |
| <b>Dimensions (W × D × H)</b><br>Unit: mm     |                            | 820 X 450 X 1900   |
| <b>Mass</b>                                   |                            | 68 kg Net  |
| <b>Operating conditions</b>                   |                            | Operating temperature: 5°C - 35°C ,      Storage temperature: -15°C - 45°C,<br>Operating humidity: 20 % - 80 % (no moisture condensation),<br>Storage humidity: 10% - 80%,                  Atmospheric pressure: 86kPa ~ 106kPa |
| <b>Connection terminals of the Main board</b> | <b>AV IN</b>               | 1  |
|   | <b>PC IN</b>               | 3  |
|   | <b>VGA OUT</b>             | 1  |
|   | <b>HDMI Input</b>          | 2  |
|   | <b>DP Input</b>            | 1  |
|   | <b>USB</b>                 | 3  |
|   | <b>WAN IN</b>              | 1  |
|   | <b>LAN OUT</b>             | 1  |
|   | <b>S/PDIF OUT</b>          | 1  |
|   | <b>Headphone</b>           | 1  |
|   | <b>RS232</b>               | 1  |
|   | <b>TOUCH OUT</b>           | 2  |
| <b>Connection terminals of the OPS</b>        | <b>WiFi antenna</b>        | 2  |
|   | <b>DP Input</b>            | 1  |
|   | <b>HDMI Input</b>          | 1  |
|   | <b>VGA OUT</b>             | 1  |
|   | <b>Headphone</b>           | 1  |
|   | <b>MIC</b>                 | 1  |
|   | <b>LAN IN</b>              | 1  |
|   | <b>USB</b>                 | 6  |

## Notes:

1. Design and specifications are subject to change without notice.
2. Weight and dimensions shown are approximate.
3. Specifications and external appearance may be changed for the sake of improvement.

\* Due to different standby conditions, the standby power consumption of some models could be higher than 0.5W.



The terms HDMI and HDMI High-Definition Multimedia Interface, and the HDMI Logo are trademarks or registered trademarks of HDMI Licensing LLC in the United States and other countries.



PRINTED ON  
RECYCLED PAPER